

Condition of Sale can be found on our website: [essentra.com](http://essentra.com).

Essentra Components does not warrant that the files will be error free and may create new versions ("Upgrades") at any time, which may correct such errors. Essentra Components has no obligation to notify you of such upgrades. Any upgraded file will be published to the website, when it becomes available.

You are not permitted to load any of the files on to a network server for the purposes of distribution to one or more other computer(s) on that network or to effect such distribution. Essentra Components shall not be liable for any loss or damage whatsoever or however caused, arising directly or indirectly from the use of the files.

**UNCONTROLLED COPY**

STATUS

**APPROVED DRAWING**

**UNLESS OTHERWISE STATED**

**ALL DIMENSIONS IN mm**

**DO NOT SCALE**

LINEAR TOLERANCE

SIZE	(0)	(0.0)	(0.00)
0-10	±0.5	±0.15	±0.10
>10-30	±0.5	±0.20	±0.15
>30-50	±0.5	±0.30	±0.20
>50-100	±0.8	±0.50	±0.25
>100-200	±1.5	±0.80	±0.40
>200-300	±2.0	±1.20	±0.80
>300-500	±3.0	±2.00	±1.00
>500	±5.0	±3.00	±1.50

THIRD ANGLE PROJECTION

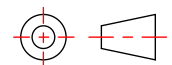

ANGULAR TOLERANCE ±0.5 DEGREES  
 UNSPECIFIED RADII 0.25mm  
 DRAFT ANGLE 0.5 DEGREES  
 DIMENSIONS IN BRACKETS [ ] ARE  
 IN INCHES FOR REFERENCE ONLY

CREATE DATE	19.06.2023	NYLON 6/6	MATERIAL
ITEM CODE	10184035	NATURAL	COLOUR
LEGACY NUMBER	10SCM003006	-	FINISH

TITLE:  
**SHOULDER WASHER**  
**3.1X4X6.2X1X6**

DWG. No.	10184035	SCALE	SHEET	ISSUE
		2:1	1 of 2	1

SECTION Y-Y

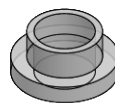
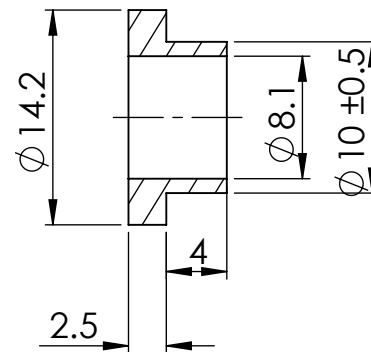
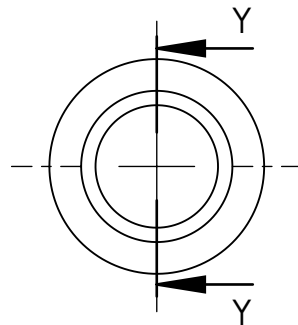

1:1

Condition of Sale can be found on our website: [essentra.com](http://essentra.com).

Essentra Components does not warrant that the files will be error free and may create new versions ("Upgrades") at any time, which may correct such errors. Essentra Components has no obligation to notify you of such upgrades. Any upgraded file will be published to the website, when it becomes available.

You are not permitted to load any of the files on to a network server for the purposes of distribution to one or more other computer(s) on that network or to effect such distribution. Essentra Components shall not be liable for any loss or damage whatsoever or however caused, arising directly or indirectly from the use of the files.

**UNCONTROLLED COPY**

STATUS

**APPROVED DRAWING**

**UNLESS OTHERWISE STATED**

**ALL DIMENSIONS IN inches**

**DO NOT SCALE**

LINEAR TOLERANCE

THIRD ANGLE PROJECTION

SIZE	(0.00)	(0.000)	(0.0000)
0 - 0.394	±0.020	±0.006	±0.004
>0.394 - 1.181	±0.020	±0.008	±0.006
>1.181 - 1.969	±0.020	±0.012	±0.008
>1.969 - 3.937	±0.031	±0.020	±0.010
>3.937 - 7.874	±0.059	±0.031	±0.016
>7.874 - 11.811	±0.079	±0.047	±0.031
>11.811 - 19.685	±0.118	±0.079	±0.039
>19.685	±0.197	±0.118	±0.059

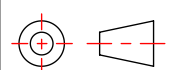

ANGULAR TOLERANCE  
 ±0.5 DEGREES  
 UNSPECIFIED RADII 0.010 inch  
 DRAFT ANGLE 0.5 DEGREES  
 DIMENSIONS IN BRACKETS [ ]  
 ARE IN INCHES FOR  
 REFERENCE ONLY

CREATE DATE	19.06.2023	MATERIAL	NYLON 6/6
ITEM CODE	10184035	COLOUR	NATURAL
LEGACY NUMBER	10SCM003006	FINISH	-

TITLE: <b>SHOULDER WASHER 3.1X4X6.2X1X6</b>			
DWG. No.	10184035	SCALE	SHEET
		2:1	2 of 2
			ISSUE
			1

SECTION Y-Y

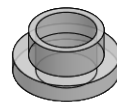
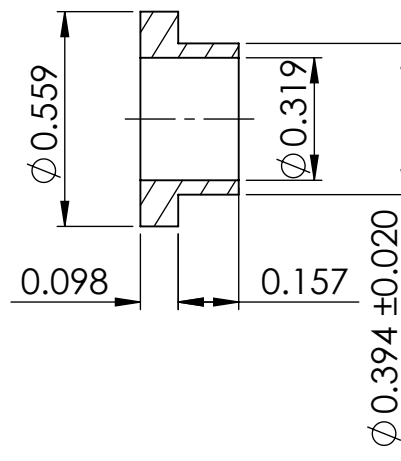
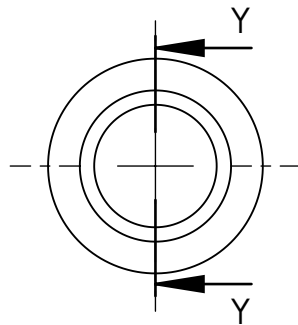

1:1